



Seit 1877

Kiefer

Luft- und Klimatechnik

Neue Wege mit Luft

Technical Information

Chilled ceiling panel INDUCOOL-Compact

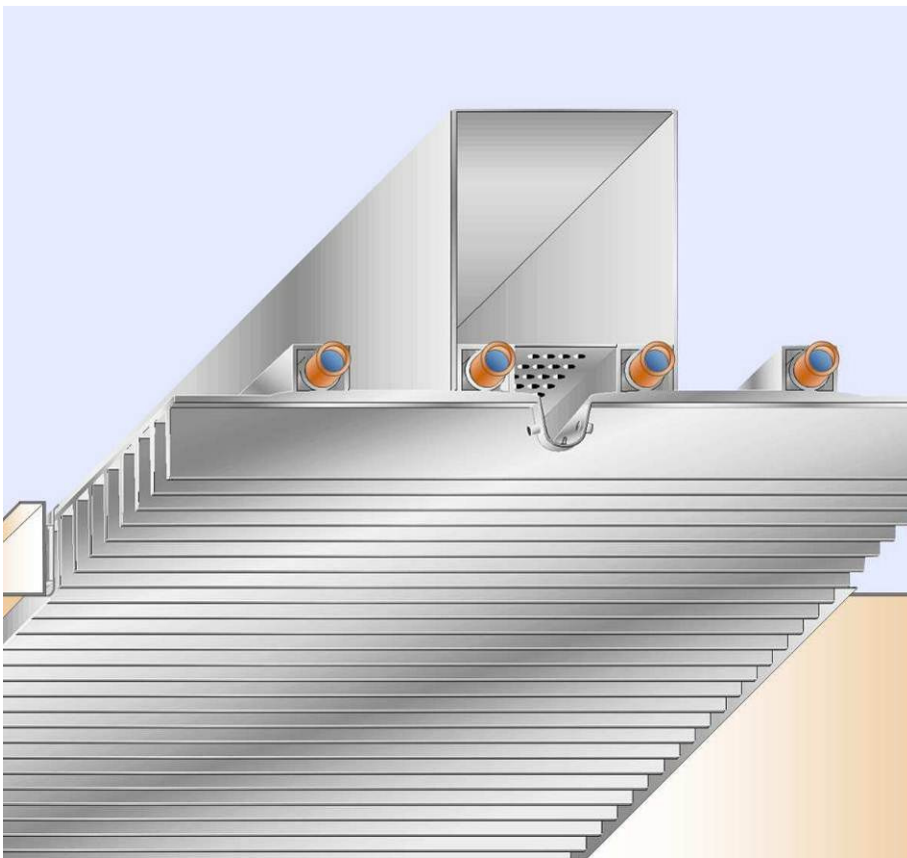

- **Cooling with air and water**
- **High cooling capacity with low energy costs**
- **Draught-free air distribution**
- **Suitable for all types of ceilings**
- **Takes up less than 10 % of a ceiling's surface**



• Features	2
• System comparison	3
• Function	4
• Technical data	5
• Installation	14
• Tender text	22
• Specification text	23

FEATURES

Performance features for the chilled ceiling panel INDUCOOL-Compact

- **Installed height is very low at 145 mm**
- **High flexibility of room layout**
- **Short installation times on site thanks to comprehensive range of installation accessories**
- **High cooling capacity (cooling with air and water)**
- **Low energy costs thanks to utilisation of the cooling potential of outdoor air (free cooling)**
- **Draught-free air distribution through proven INDUL technology**
- **Easy to clean**
- **Complies with the hygiene requirements according to the VDI 6022**

Cooling with air and water?

Powerful computers in offices, lots of lighting, and extensive glass facades: if room temperatures are to stay comfortable under rising cooling loads, a reliable **cooling system** is called for.

In addition, for good ambient air quality and effective control of humidity, a ventilation system with an adequate supply of outdoor air is important.

In principle, a cooling system can be designed to work with air or water. The very high specific heat capacity of water permits small duct cross-sections and, thus, **low costs** for the plant and its operation. Using purely outdoor air with no recirculation is the ideal precondition for a sound, hygienic ventilation plant.

Frequently, however, the specific air exchange rates of 6...10 m³/hm² common today are not sufficient to deal with the cooling load. In addition to air cooling, room related cooling with water is needed. The optimum and economical solution is therefore:

Cooling with air and water!

INDUCOOL-Compact combines air and water cooling with the advantages of both systems – to make it twice as economical.

The mean average, annual outdoor temperature in central Europe is between 8°C and 10°C. With air cooling, by using the cooling capacity of the outdoor air, which is anyway hygienically necessary, a substantial quantity of energy can be saved (free cooling). Additional cooling with water is restricted to the periods in which the cooling capacity of the outdoor air would be inadequate.

The advantages of the INDUCOOL-Compact chilled ceiling panel when compared to other systems:

Chilled ceiling with window ventilation

Particularly on hot and humid days when additional cooling would be desirable, window ventilation or cooling must be avoided, because of the danger of condensation.

The INDUCOOL-Compact chilled ceiling panel avoids the risk of condensation by introducing dehumidified supply air.

Displacement air for air distribution

Displacement air for air distribution certainly has its advantages. The combination of a displacement air system with a chilled ceiling does, however, result in increased energy consumption.

INDUCOOL-Compact, an integrated air water system, consumes less energy and provides better ambient air quality.

As shown in the illustration below, the supply air for INDUCOOL is fed into the system through a connecting tube and is then distributed along the entire length of the chilled ceiling panel through an air chamber. The supply air then enters the room through fine nozzles that are located between the panels' cooling fins.

This highly inductive air distribution method efficiently transfers heat and effectively cools the induced ambient air. The heat removed from the ambient air is discharged through water that flows through meandering copper pipes.

Due to the extremely high induction, a quite rapid temperature and speed reduction of the supply air is achieved.

The fine jets of supply air fed into the room ensure that air flows effectively through a room without creating any draughts.

The compact design with an installation height of only 145 mm makes possible the integration of the unit into nearly any ceiling system. The installation height of 145 mm is the distance from the upper edge of the air chamber to the lower edge of the ceiling.

For acoustic ceilings, which have access through the hollow space of the ceiling, a design height with an installation space of only 100-150 mm must be assumed, meaning that **the chilled ceiling panel requires no additional ceiling hollow space.**

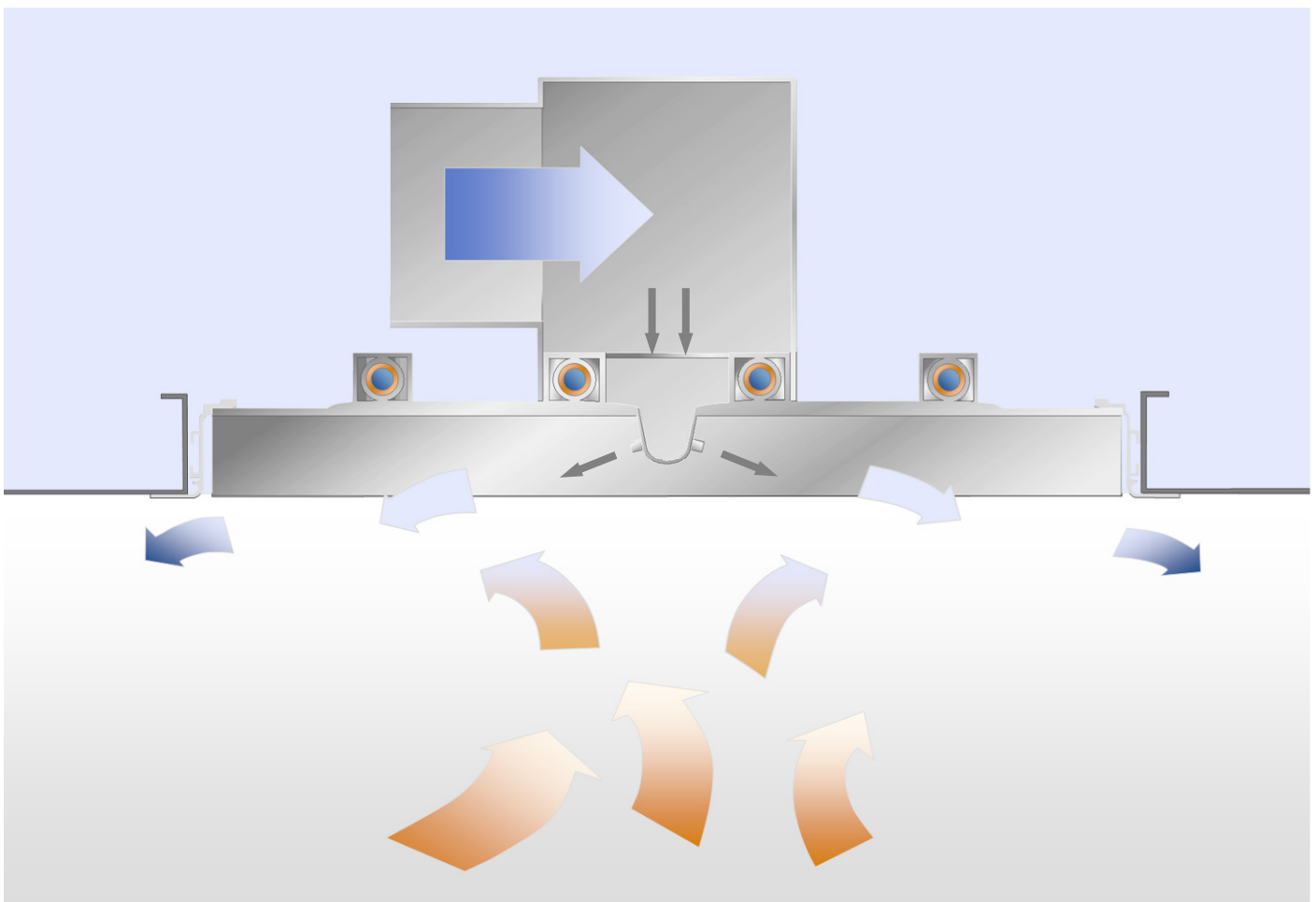

Schematic Drawing

Structure

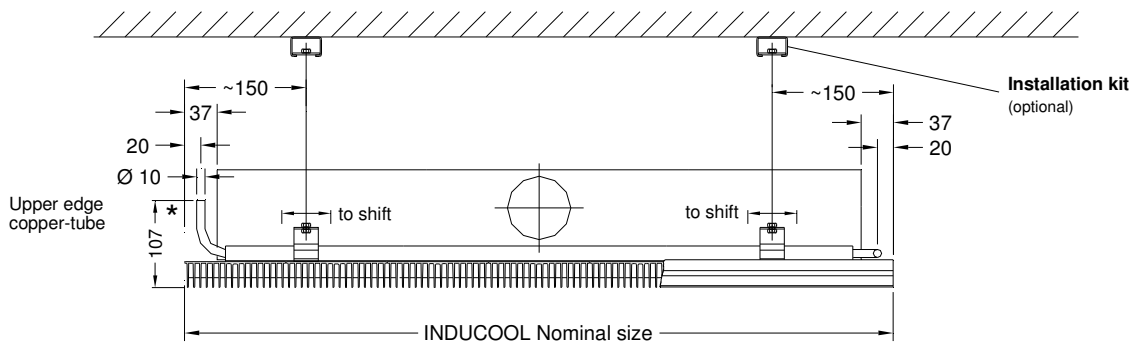
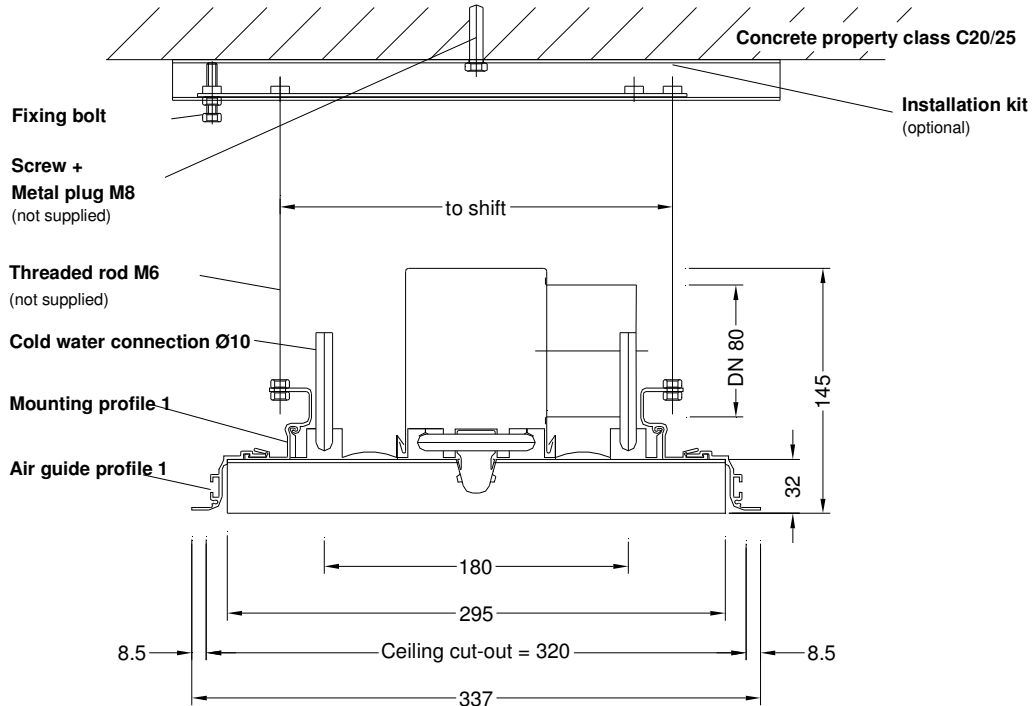

* Cold water connection left hand side

Main dimensions

Length	1000 to max. 2500 mm in 125 mm sections, i.e. 1000, 1125, 1250 mm etc. (fitting lengths on request)
Width	295 or 275 mm (special widths available on request)
Weight	When filled with water, approx. 12 kg/m
Visible surface	Anodised aluminium, natural colour, RAL colour of customer's choice against a surcharge

Free design service

Due to the number of factors that have to be taken into account, calculating the right dimensions for the chilled ceiling panel is rather complex. For this reason, we provide a computer-aided dimensioning calculation service **free of charge**.

In order to calculate the chilled ceiling panel dimensions and layout for a particular project and draw up tender documents, we require a floor plan of your building or the room in question, the height of the room, and an indication of its use, cooling load and specific air flow rate. Please use the specification text on page 23 to provide us with these details.

The following diagrams and formulas are intended to help you to roughly calculate the dimensions and arrangement of the chilled ceiling panels.

Design parameters

In the following design examples the usual design parameters were employed. These must be checked in relation to your building and modified if necessary.

Room height H_R	3,0 m
Room temperature t_{IDA}	26 °C in accordance with EN 13779
Supply air temperature t_{SUP}	14 °C to dehumidify the air to 9 g/kg (see diagram below)
Cold water inlet temperature t_{wV}	15 °C this is set to approx. 1K higher than the supply air temperature
Spread Δt_{wV-R} (return line – inlet line)	2K
Average local ambient air velocity \bar{v}	0.15 m/s in accordance with EN 13779
Reverberation time T_N	0.6 s to take into account the influence of room absorption

Change of state of moist air in the AHU

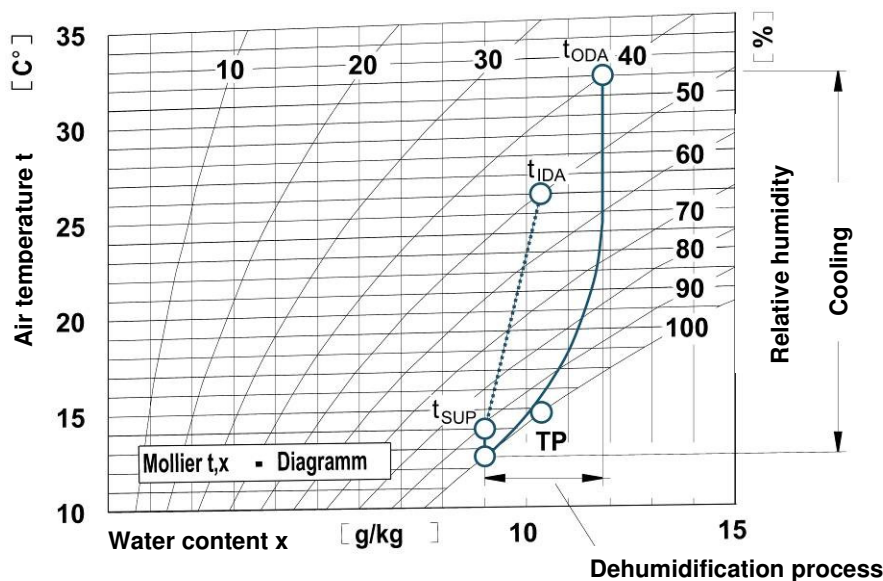

t_{ODA}	= Outdoor air temperature
t_{IDA}	= Measured ambient air temperature
t_{SUP}	= Supply air temperature
TP	= Dew point

Calculating the number of active chilled ceiling panels for a given cooling load and air flow rate

As can be seen in the graph below, for a specific air flow rate of $9 \text{ m}^3/\text{hm}^2$ (which corresponds to an approx. triple air exchange rate) and a cooling capacity of $84 \text{ W}/\text{m}^2$, 6 m^2 of ceiling surface can be cooled by one metre of chilled ceiling panel. Thus, per each 6 m^2 of ceiling area, a chilled ceiling panel 1 m long and with a width of 295 mm is required.

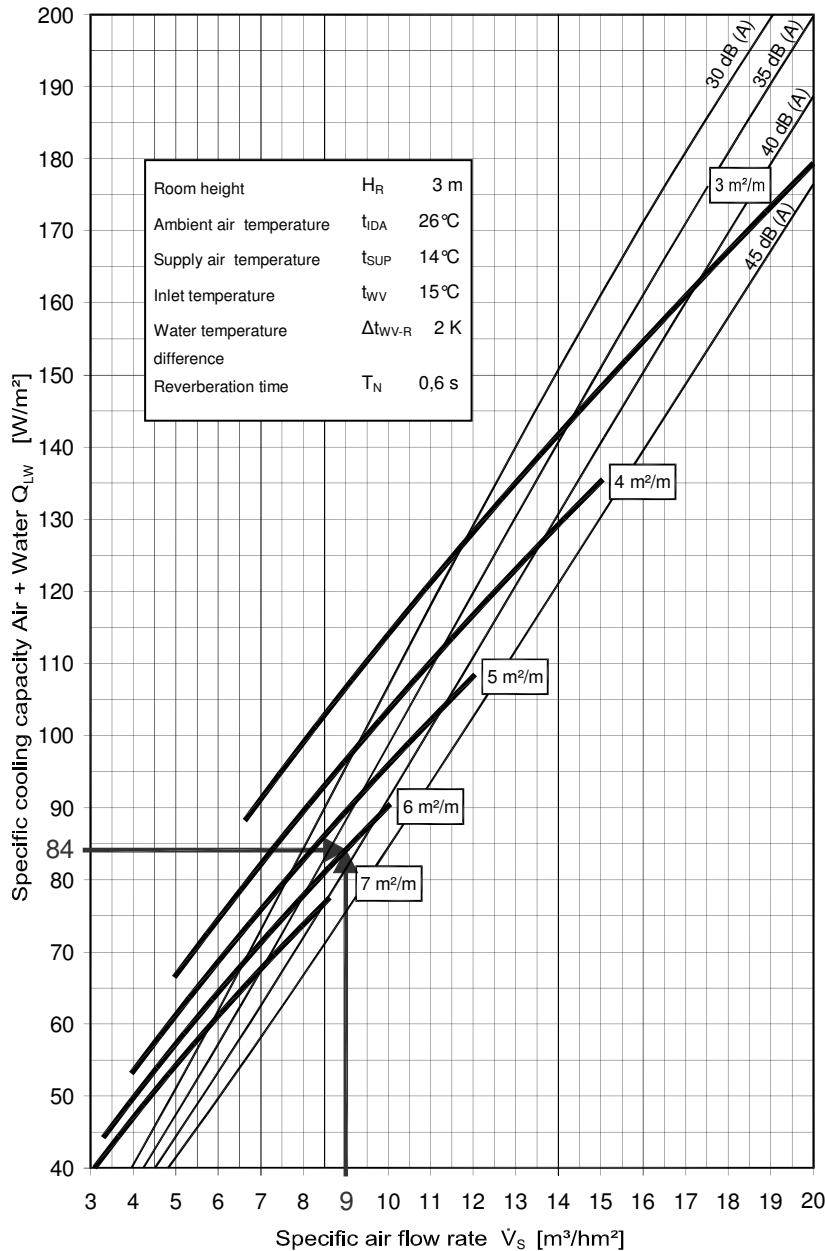

The required specific cooling capacity depends on the performance category selected. The performance category defines the jet cross diameter; there is a choice of three categories:

- Performance category F2.0
- Performance category F2.3
- Performance category F2.8

The graph shown here refers to performance category F2.0

Calculating the chilled ceiling panel's total cooling capacity for a given air flow rate

The graph below shows the total cooling capacity [W/m chilled ceiling panel] in relation to the air flow rate [m³/hm]. As can be seen in this graph, each chilled ceiling panel achieves a total cooling capacity of 421 W/m at an air flow rate of 41 m³/hm if arranged in parallel rows at distance of ≥ 4 m.

The chilled ceiling panels' cooling capacity depends on the distance between the parallel rows. Small distances between the panels reduce their cooling capacity.

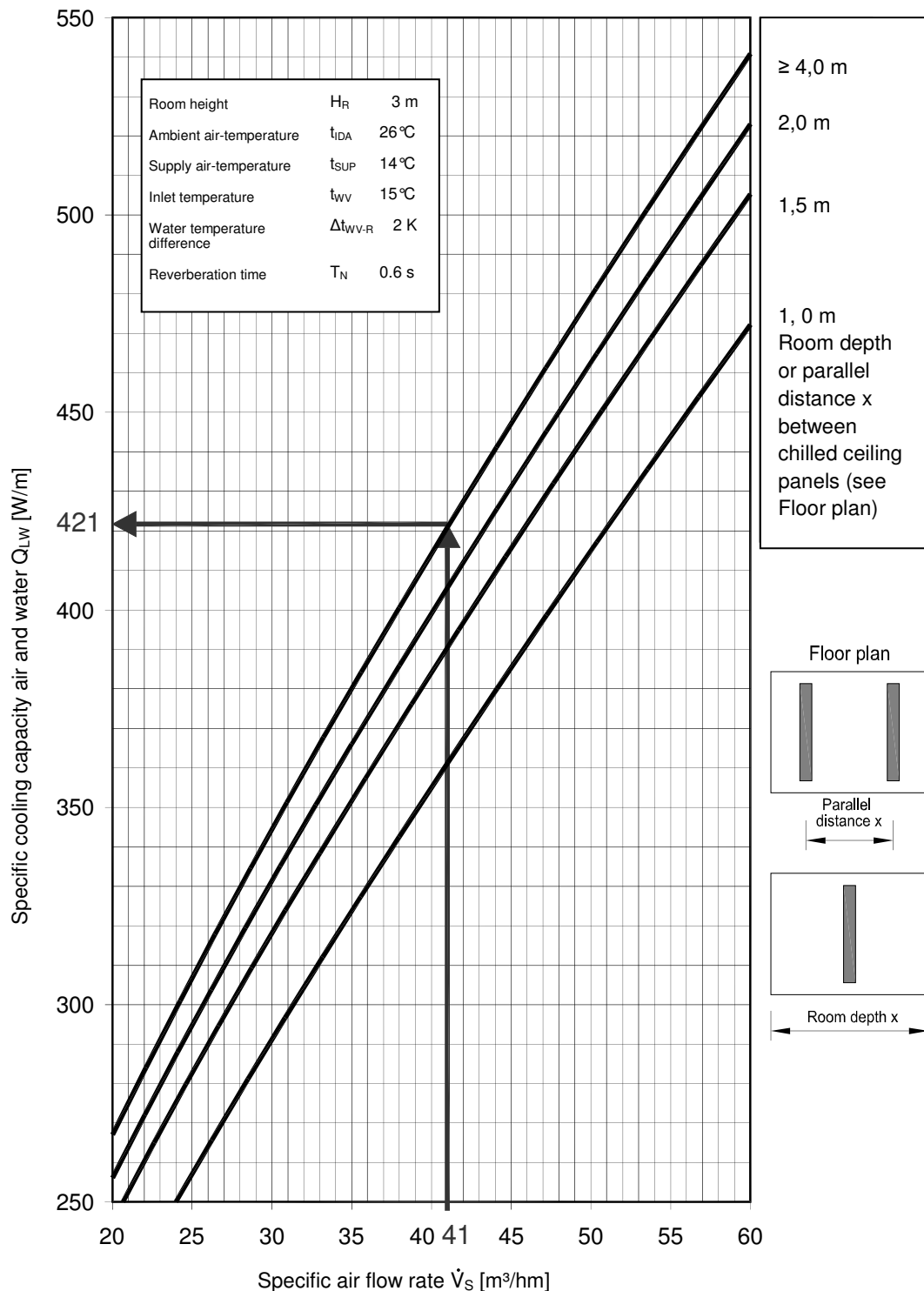

Design example

Room size	3 window axes at 1.6 m; depth of room, 4.8 m; each axis features a 100 mm wide bandraaster bar
Area of room	23 m ²
Cooling load	80 W/m ² ± 1840 W
Air flow rate	8 m ³ /hm ² ± 184 m ³ /h
Selection information	See page 6 Example layouts
Arrangement	3x 1.5 m long chilled ceiling panels in the centre of the room and parallel to the facade
Air flow rate	184 : 3 ± 61 m ³ /h chilled ceiling panel ± 41 m ³ /hm chilled ceiling panel
From graphs on page 8	In a room with a depth of ≥ 4 m and an air flow rate of 41 m ³ /hm, the chilled ceiling panels will have an output of 421 W/m
Total cooling capacity of chilled ceiling panel	421 W/m x 1.5 m x 3 chilled ceiling panels is 1894 W ± 82 W/m ²
Result	The required cooling load of 80 W/m ² can be covered.

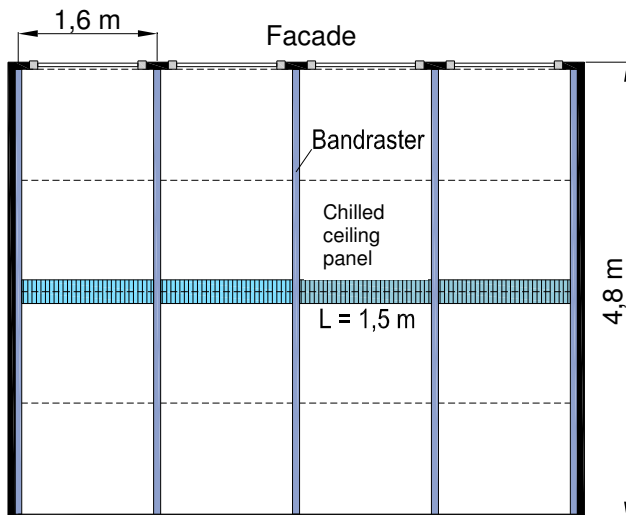

Static pressure loss on supply air side $\Delta p_{s\ SUP}$:

$$F2.0 \quad \Delta p_{s\ SUP} = \dot{V}_{SUP}^2 / 14 \text{ [Pa]}$$

$$\dot{V} = [\text{m}^3/\text{hm}]$$

$$F2.3 \quad \Delta p_{s\ SUP} = \dot{V}_{SUP}^2 / 21 \text{ [Pa]}$$

$$\dot{V} = [\text{m}^3/\text{hm}]$$

$$F2.8 \quad \Delta p_{s\ SUP} = \dot{V}_{SUP}^2 / 39 \text{ [Pa]}$$

$$\dot{V} = [\text{m}^3/\text{hm}]$$

Possible arrangements

- Endless possible ceiling designs
- Only takes up 5...10 % of a ceiling's area

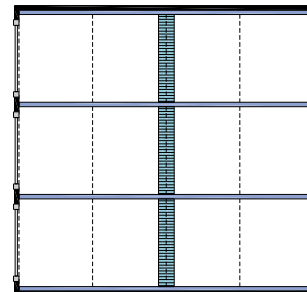

3-axis office

(Ideal design)

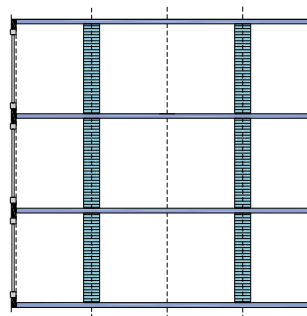

Open plan office

(Ideal design)

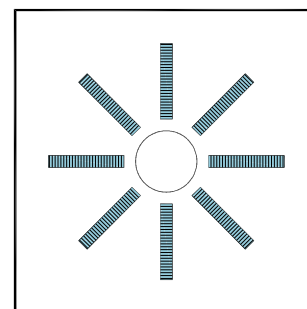

Star-shaped design for
reception areas, repre-
sentative areas

(Possible design option;
subject to consultation
with our technical sales
department)

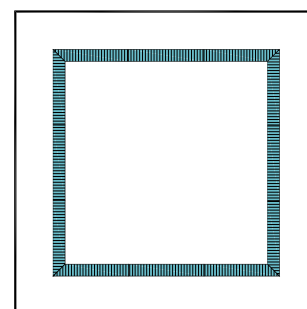

Rectangular design

(Possible design option;
subject to consultation
with our technical sales
department)

Water-side pressure loss Δp_{sw} :

$$\Delta p_{sw} = m_w^2 \times L / 3295 \text{ [kPa]} \quad m_w \text{ [kg/h]}$$

$L = \text{Length of chilled ceiling panel [m]}$

Minimum cold water mass flow 100 kg/h

The cold water mass flow actually required is given in the data sheet for our detailed design.

Calculating room air velocity and acoustics

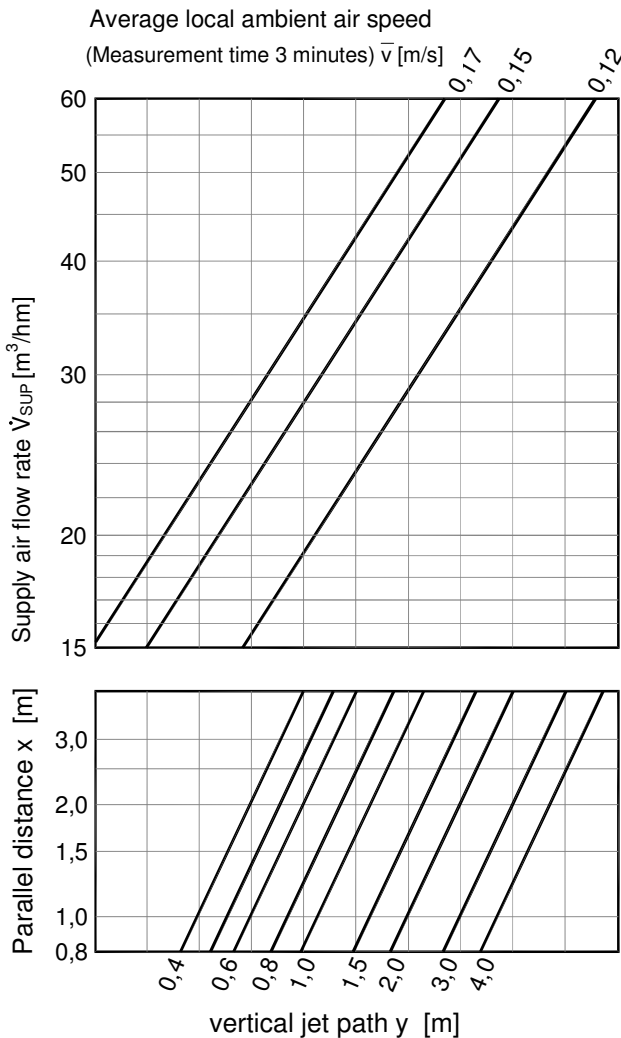

Sound pressure level for performance category F2.0

Applies to a room height $H_R = 3.0$ m

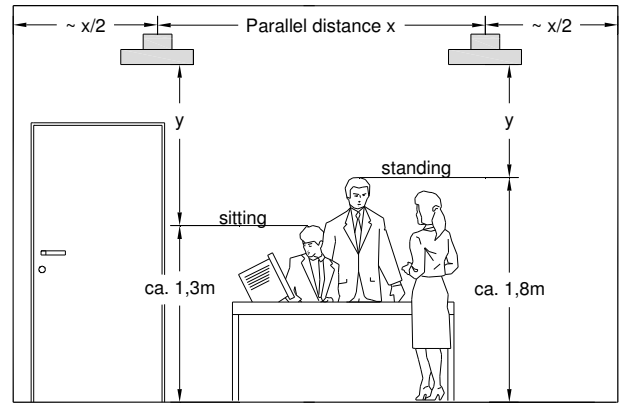
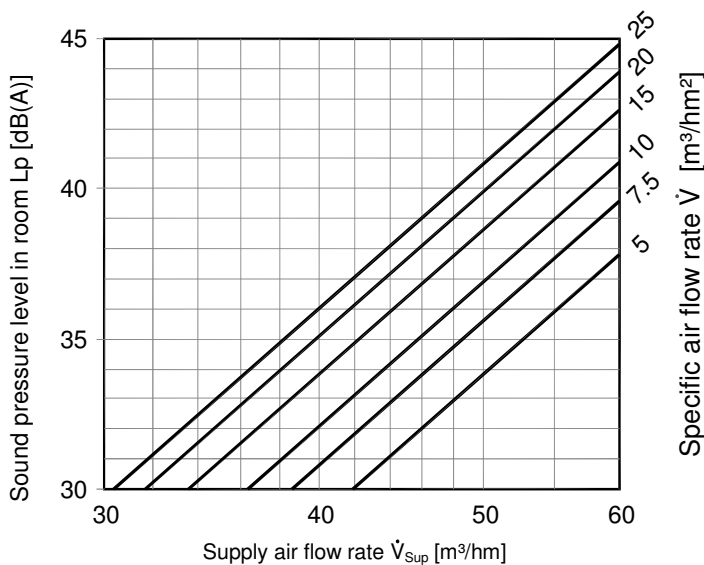

Jet path y, distance x

INDUCOOL panels should be distributed as evenly as possible over the ceiling. When doing so, fitting them in rows tends to generate better results than fitting them on their own. The stated air velocity is valid for $\Delta t_{SUP} = -12K$.

Relative sound power level ΔL_w

Frequency [Hz]	63	125	250	500	1K	2K	4K	8K
ΔL_w [dB]	+6	-3	-8	-8	-6	-5	-7	-15

Correction values ΔL_{HR} for other room heights:

H_R [m]	2,5	2,7	3,0	3,5	4,0	4,5	5,0	6,0
ΔL_{HR} [dB(A)]	+0,8	+0,4	0	-0,7	-1,2	-1,8	-2,2	-3,0

Correction values ΔL_{TN} for other reverberation times:

T_N [s]	0,4	0,5	0,6	0,7	0,8	0,9	1,0	1,2
ΔL_{TN} [dB(A)]	-1,8	-0,8	0	+0,7	+1,2	+1,8	+2,2	+3,0

Sound power level

$$L_w = 60 \cdot \log(\dot{V}_{SUP}) + 10 \cdot \log(L) - K$$

\dot{V}_{SUP} [m³/hm]
L [m]

Performance category	Correction value
F2.0	K = 65
F2.3	K = 67
F2.8	K = 69

Input attenuation ΔL_{ED}

Performance categories F2.0 – F2.8	Octave band medium frequency (H_z)						
	125	250	500	1K	2K	4K	8K
	Input attenuation [dB]						
	21	15	10	6	5	2	3

Note

The products we supply have general tolerances to DIN ISO 2768 Parts 1 and 2, which apply to the mechanical and plant engineering sectors. The aluminium extrusions used in many products have tolerances to DIN EN 755-9:2008-06. Depending on the combination and surface treatment, the components and extrusions, additional deviations of up to 2 mm may occur. Due to manufacturing tolerances, the tolerance range for calorific performance is $\pm 10\%$, and ± 2 dB for acoustic properties.

Note

The sound-pressure-level data cover only noise emitted by the chilled ceiling panel. Other sources of noise can result in an increase of the sound pressure level in a room. These graphs are not valid for combinations with other types of air diffuser. In such cases, please contact our Technical Sales Department.

The ventilation system

When determining the supply air flow, the person or area-related minimum outdoor air flow to EN 13779 must be observed.

We recommend that the outdoor air flow should be not less than $8 \text{ m}^3/\text{hm}^2$. This allows compliance with the usual room loading of < 1.0 dezipol.

If dehumidification to maximum absolute room air humidity of 10 g/kg is carried out, corresponding to a supply air temperature of $14 \text{ }^\circ\text{C}$, then condensation on the cooled ribbed panels can be very effectively prevented (see "Change of state of moist air" on page 6). For comfortable conditions in a room, make sure the supply air is adequately dehumidified.

In an energetically optimised plant, the necessary minimum outdoor air flow can be used fully to cover the cooling load. The supply air temperature can be significantly lower than the ca. $16 \text{ }^\circ\text{C}$ frequently employed.

INDUCOOL permits supply air temperatures of $12..14 \text{ }^\circ\text{C}$. In central Europe, the average annual outdoor temperature is $8..10 \text{ }^\circ\text{C}$ (DIN 4710). For most of the year, cool outdoor air is available which can be used for cooling with no additional consumption of energy.

In contrast to a system which uses displacement air combined with a chilled ceiling, the INDUCOOL solution takes advantage of the cooling capacity of the cool air. The energy cost calculations show that this is an exceptionally economical solution.

To comply with hygiene requirements where appropriate, a 2-stage filter consisting of pre-filter and fine filter must be incorporated as specified in EN 13779 (RAL1 + RAL2).

Design Information

The average "local air velocity" specified by DIN EN ISO 7730:2007 is the average air velocity measured over 3 minutes at any point in the common area under consideration.

Permissible velocity: DIN EN ISO 7730:2007

Measuring procedure: DIN EN 13182:2002

Common area: DIN EN 13779:2007

The "common area" limits and highest permissible "local air velocity" have to be agreed by the building owners and consultant or technicians.

Our diagrams provide information on the average "local air velocities" when the cooling system is operating and relative to the specific supply air flow rate. This "average local air velocity" has been calculated on the basis of measurements taken at a number of measuring points that were evenly distributed over a room. 50% of these velocities are above and 50% below the diagram's value.

The actual local air velocities can deviate from this value as a result of the level of turbulence of the mixed air flow or air currents not generated by the ventilation system but objects like the facade, radiators and similar.

Hydraulic system, measurement and control technology

The cold water connection to the chilled ceiling panel is by means of plug-in connectors with oxygen diffusion-resistant reinforced hoses.

If the chilled ceiling panel is to be rigidly connected, it must be ensured that the pipes are not subject to any strains once they are installed.

To ensure that all consumers are supplied according to their needs, the cold water supply should be installed either using the Tichelmann system, or with hydraulic compensation using measuring regulation valves.

Measures must be taken to prevent condensation occurring during operation. The cold-water feed temperatures must therefore be chosen according to the state of the air in the room.

When carrying out design calculations, the gains in humidity in the room and possible infiltration must be taken into account.

Windows that can be opened must be taken into account. In this case under some weather conditions, it will only be possible to prevent condensation when dew point sensors are used as condensation protection. When a window is opened, either the water supply temperature must be raised according to the outdoor enthalpy, or the cold-water supply must be shut off.

Regulation

The chilled ceiling panels' cooling capacity is regulated only through the water supply. Adjusting the cooling capacity by reducing the primary airflow rate (VVS) causes unstable flow conditions at the panel and is therefore unsuitable for controlling them. If the cooling panels are installed in rooms that are not in constant use (e.g. conference rooms), it is certainly advisable to reduce or totally switch off the supply air supply.

In all other cases, it is not actually possible to switch off the supply air supply, because the system is designed to

run with the minimum required supply air flow rate, which should remain constant.

The water-based part of the system's total cooling capacity (water and air) can be adjusted. Ideally, the water inlet temperature should be seamlessly adjusted relative to the cooling load (regulating the inlet temperature). When doing so, it must be taken into account that the condensation point temperature is also the minimum temperature.

The water's cooling capacity is nearly linear to the difference in ambient and water inlet temperature. This is why it can be used to accurately control a panel's cooling capacity. The regulation comprises activating a mixing switch with a 3-way valve and a secondary pump.

Diagram of the inlet temperature regulation using a 3-way valve and secondary pump

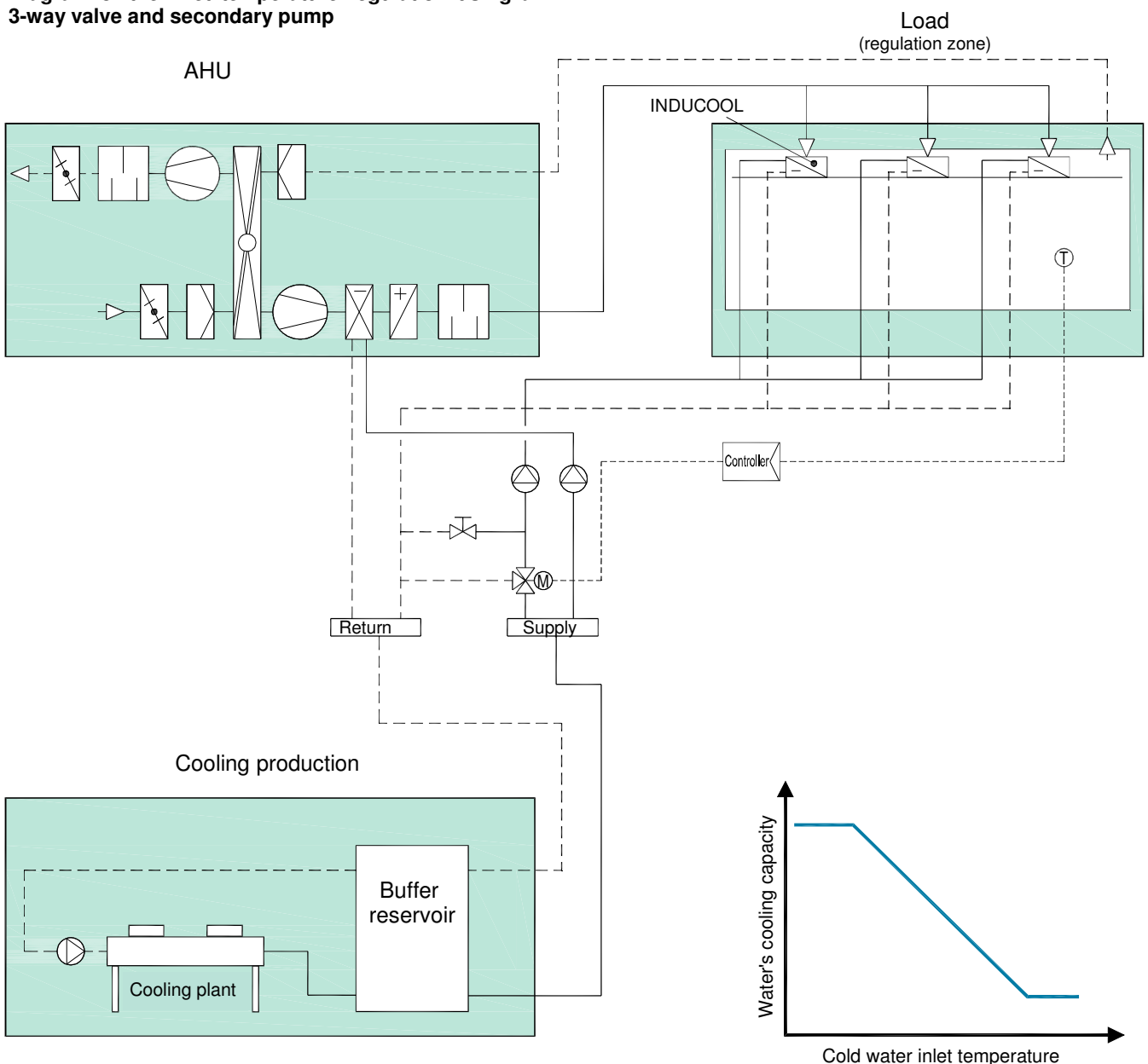

Another potential way to regulate the water's cooling capacity is to adjust the volume of water (throttle switch). When doing so, it is necessary to use a permanently-on gate valve that opens and closes depending on the ambient temperature (2-way switch).

Even though the water volume is consequently not continuously adjusted (only Open/Closed), it is still advisable to use permanently-on valves because the ribbed base plate will be allowed to cool for longer still when the water supply is switched on again due to the valve's long running time and good opening characteristics. This leads to significantly better and more comfortable indoor climates.

As the control characteristic of the water's cooling capacity is no longer linear when it is controlled through the volume of water in the system, the quality of this control mechanism is far less efficient than that achieved when controlling the inlet temperature with 3-way valves.

If INDUCOOL is also to be used to provide heating, the system's cooling/heating capacity can only be regulated by using a mixing switch. The CV of the control valves must be chosen in accordance with VDI 2173. The chilled ceiling panel's water pressure loss data required for designing the system are detailed in our design information on page 9.

Diagram of the water flow regulation using a 2-way valve

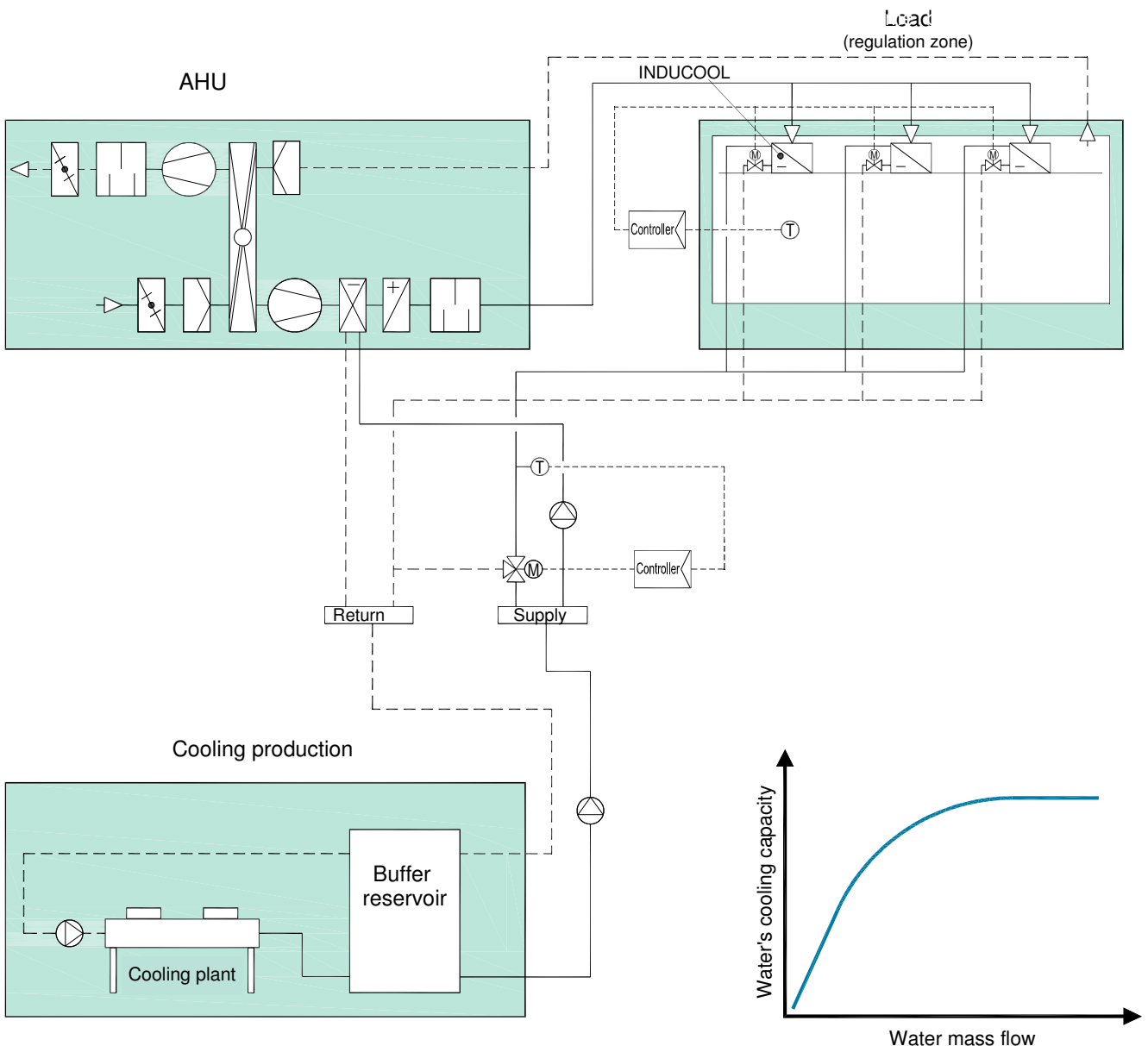



Heating with INDUCOOL

Note

If heating with INDUCOOL, we recommend using warm water inlet temperatures of no more than 30 °C.

The convective heat given off by the water-filled chilled ceiling panel causes pockets of warm air to form under the ceiling. As a result, the entire ceiling is heated up evenly and consequently also indirectly heats the entire room (radiant heating ceiling).

However, as with all chilled ceilings, the facade will not be adequately protected against cold radiation and from cold air drops. This will result in uncomfortable indoor climates in particular in fully glass-fronted buildings. For this reason, it is always best to heat a room by fitting a static heater right underneath the window.

Arrangement and installation

The best way to arrange the chilled ceiling panels is to distribute them evenly over the entire area of the room. In larger rooms, such as showrooms, the chilled ceiling panels can also be arranged in continuous rows.

The chilled ceiling panels can be suspended directly from the bare ceiling by four threaded rods.

We offer system solutions and installation accessories for a diverse range of different ceiling systems.

These system solutions are shown in the following drawings and we can also supply these drawings as dwg, dxf and pdf files.

We recommend:

Installation on the bare ceiling with an installation kit.

With the installation kit, only 2 attachment points per cooling panel are required in the bare ceiling. In addition, adjustment in all three levels is possible when the installation kit is used.

Installation with overlay brackets especially for system ceilings.

This installation method leads to a dimensionally accurate, detailed solution, precisely harmonised with the ceiling system. See installation examples on the following pages with connections in different conditions using corresponding air guide profiles / installation frames.

Cold water connection with reinforced hose

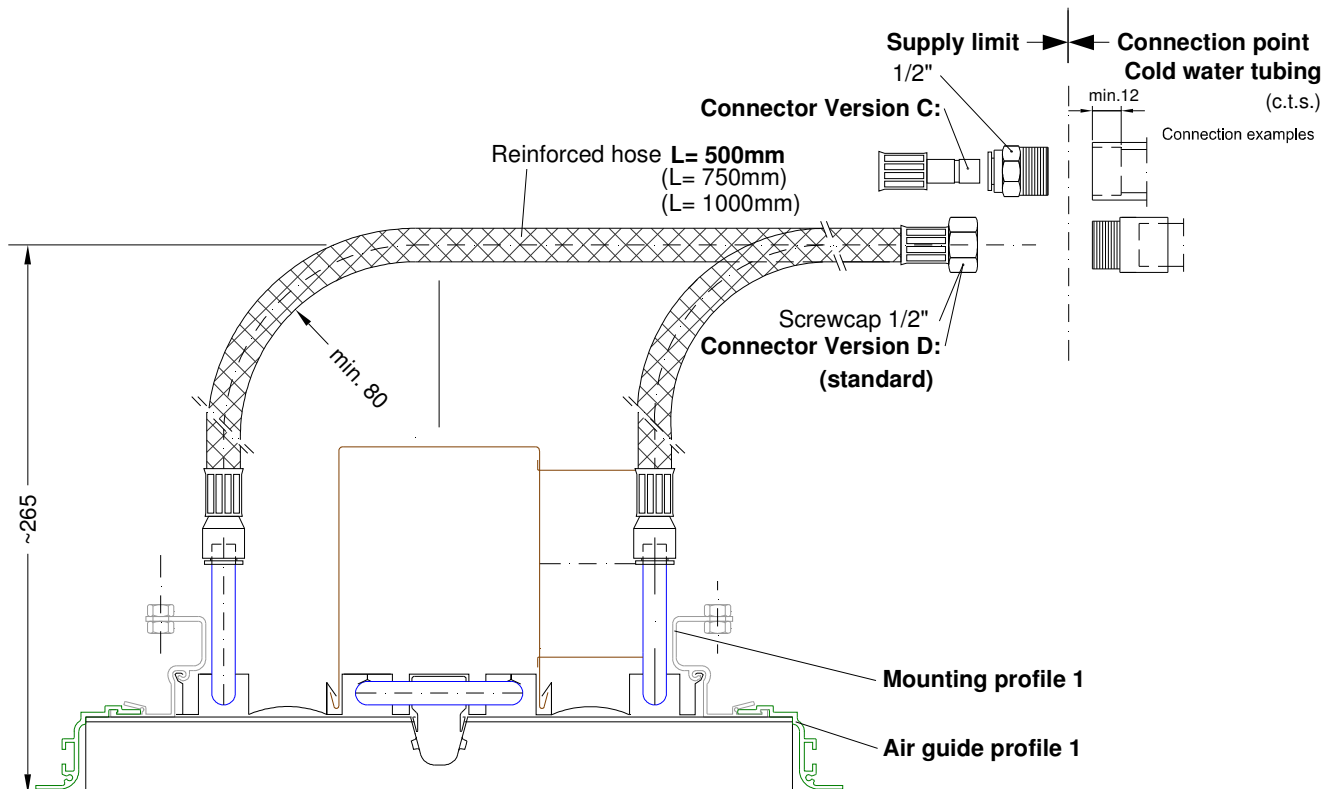
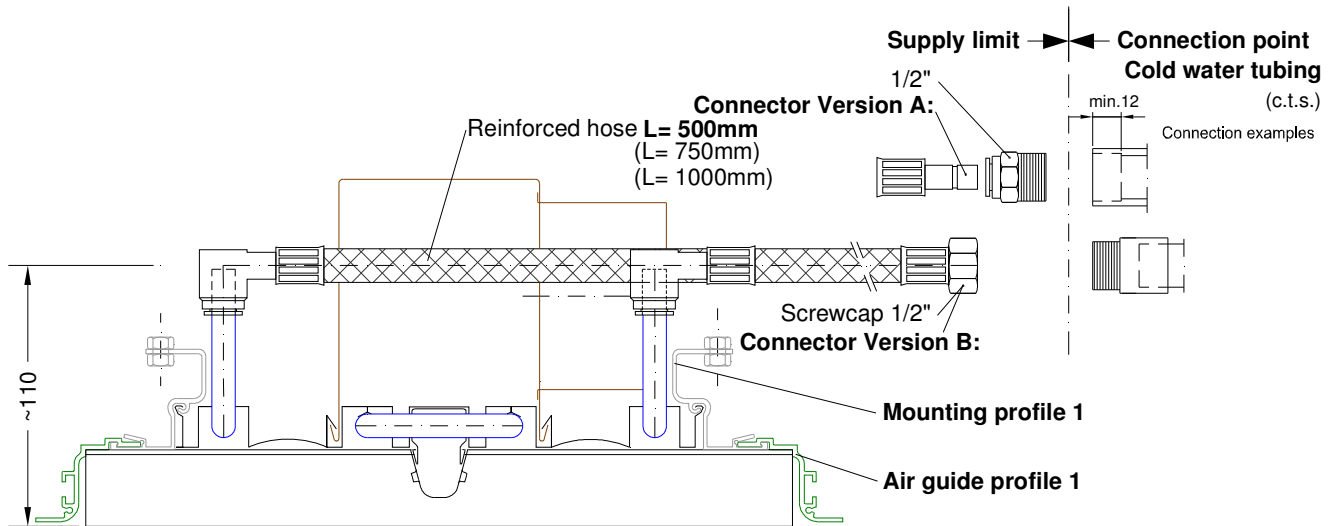

Single element - Installing with air guide profile 1 as an installation frame KL1

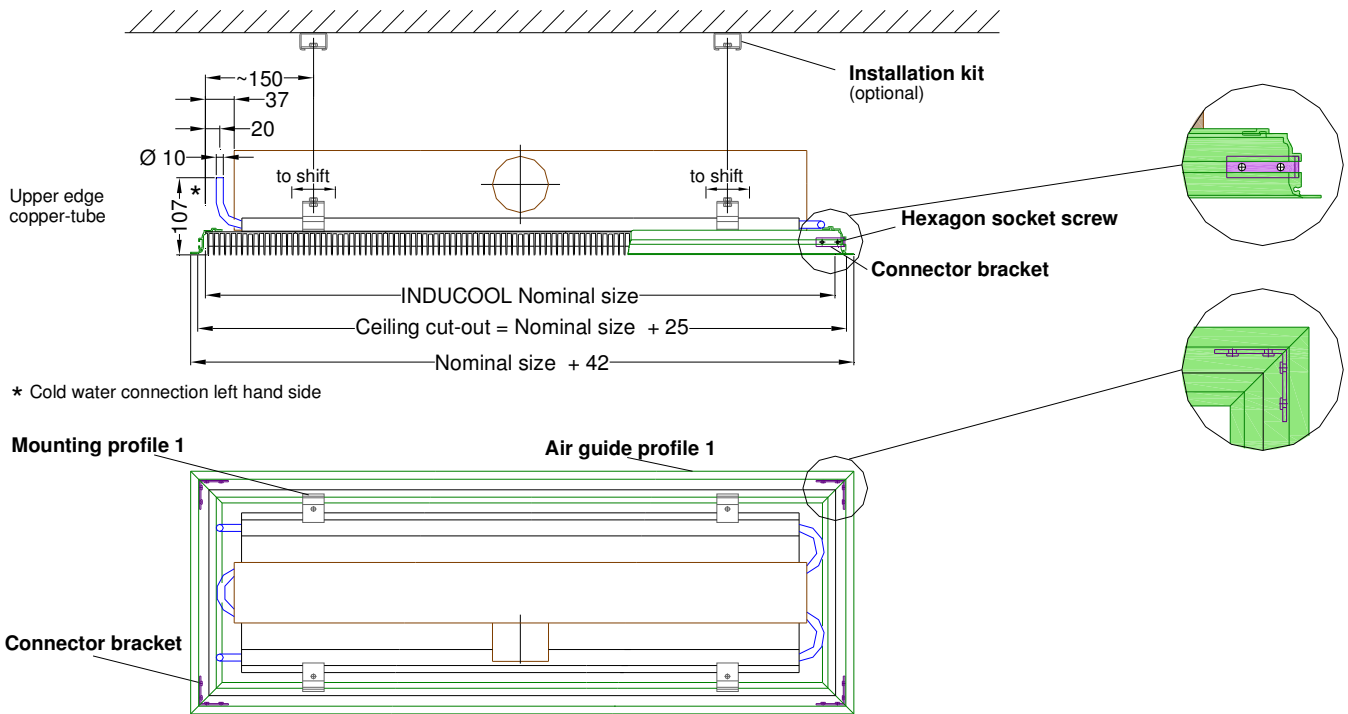

Row-installation with air guide profile 1 as an installation frame KL1

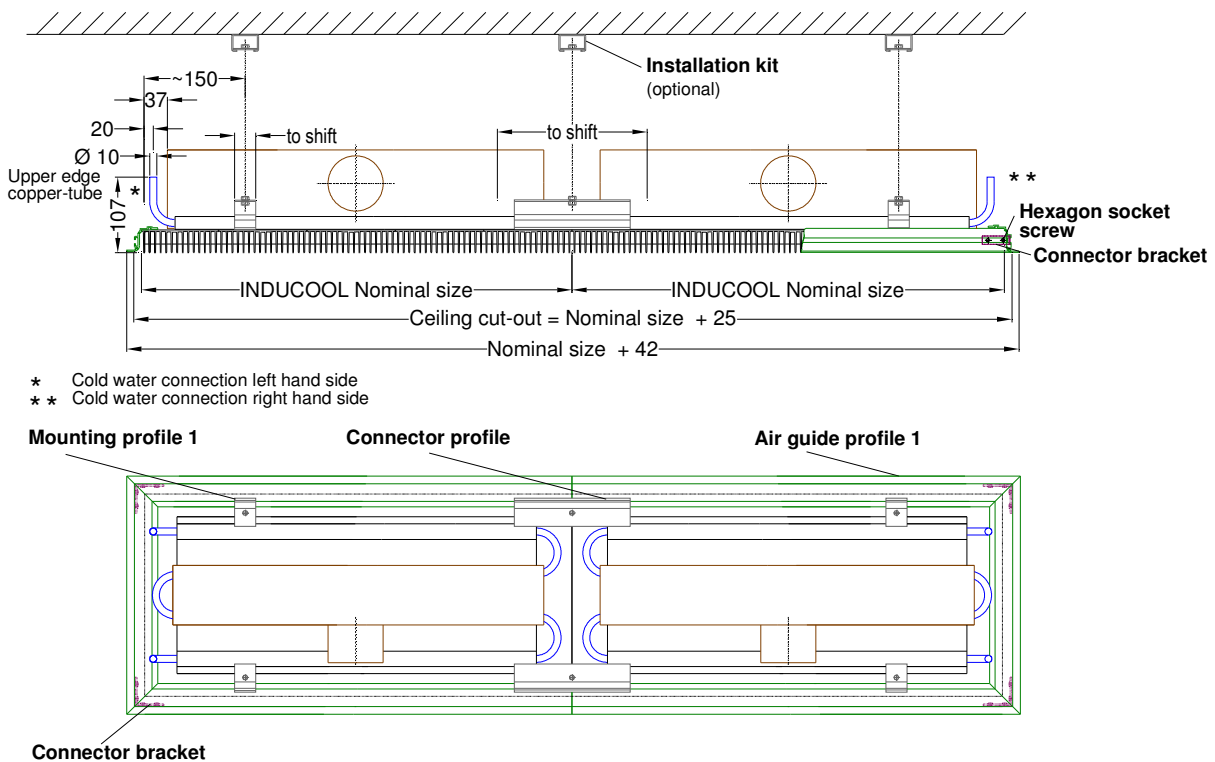

Installation in mineral fibre ceilings with air guide profile 1 (supported on bandraster)

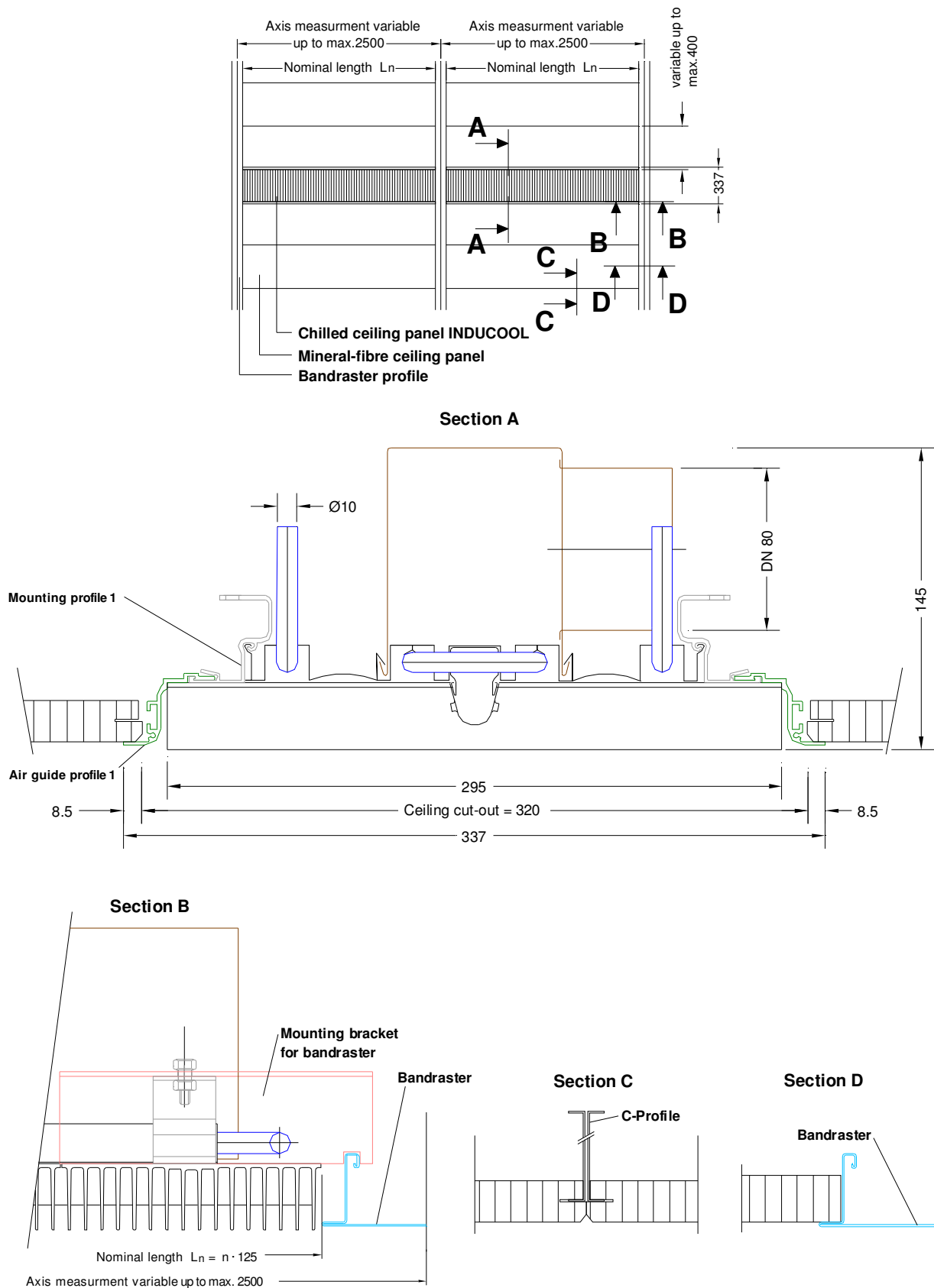

Installation in metal ceilings with air guide profile 3 (supported on bandraster)

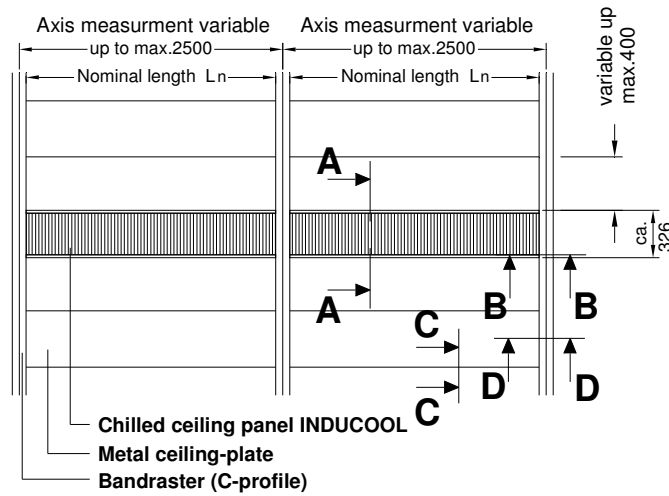

Section A

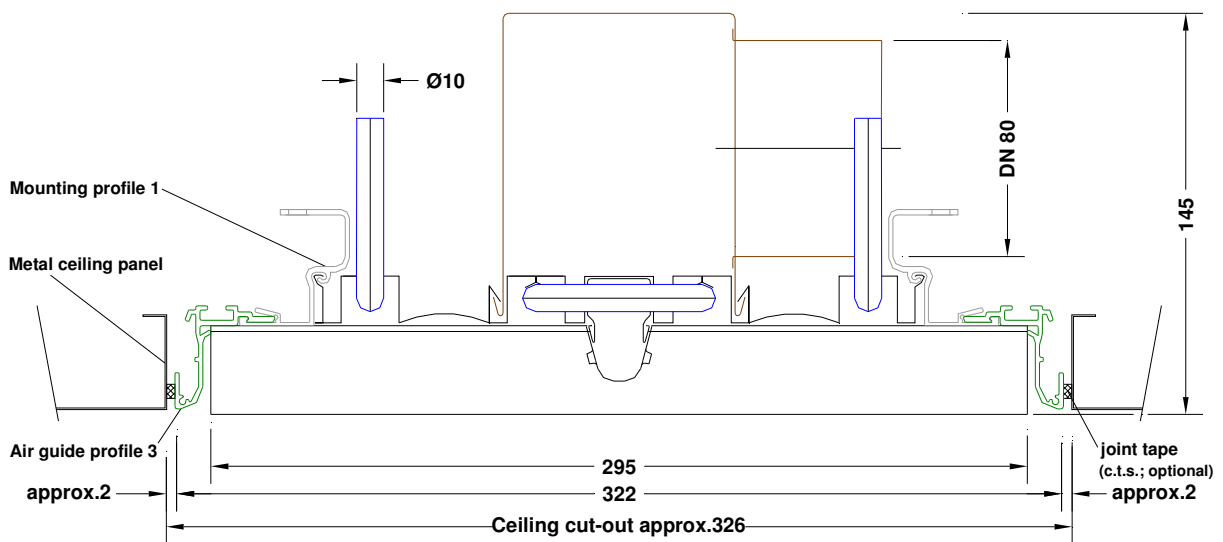

Section B

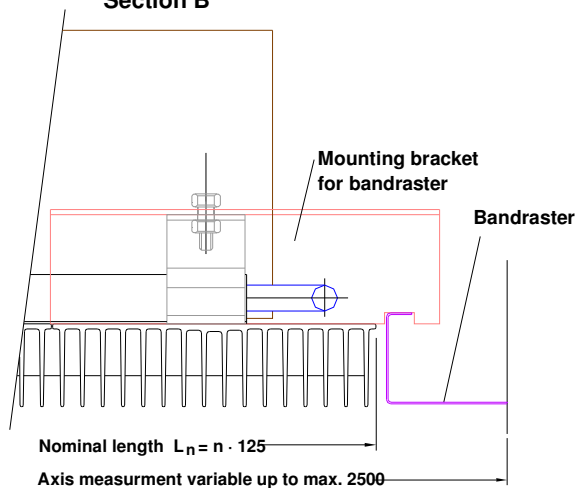

Section C

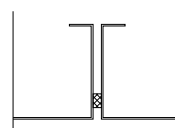

Section D

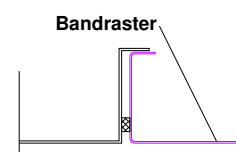

Installation in metal ceilings with air guide profile 3 (using installation kit)

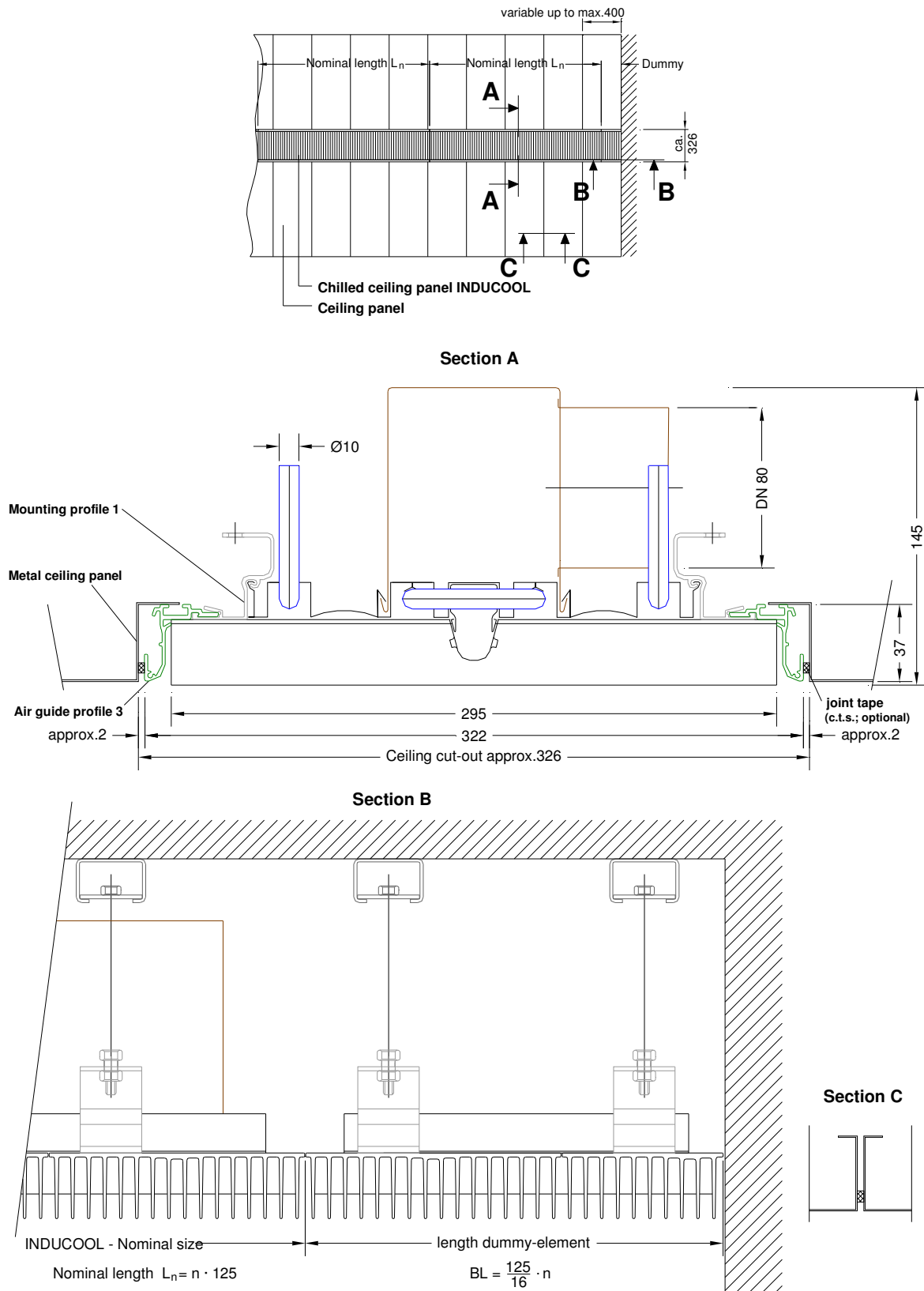

Installation in plasterboard ceilings with air guide profile KL-3-GK

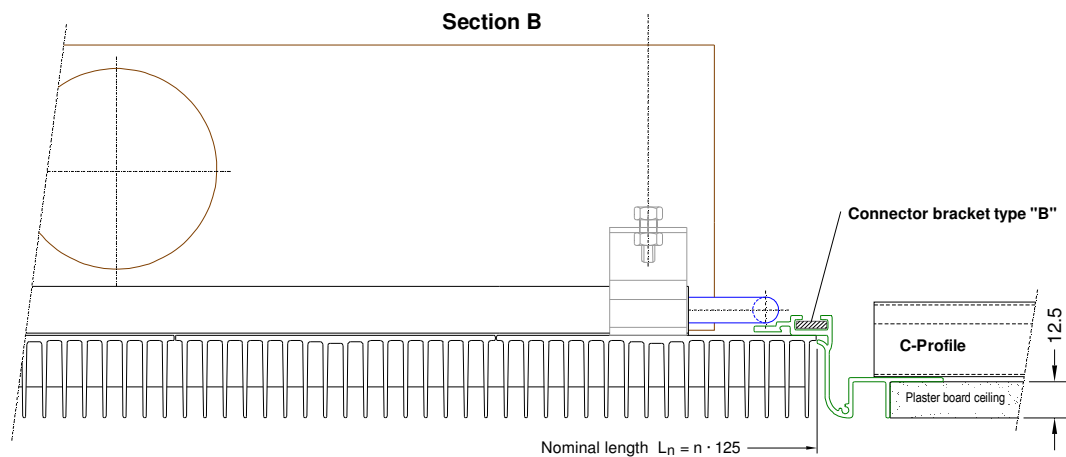
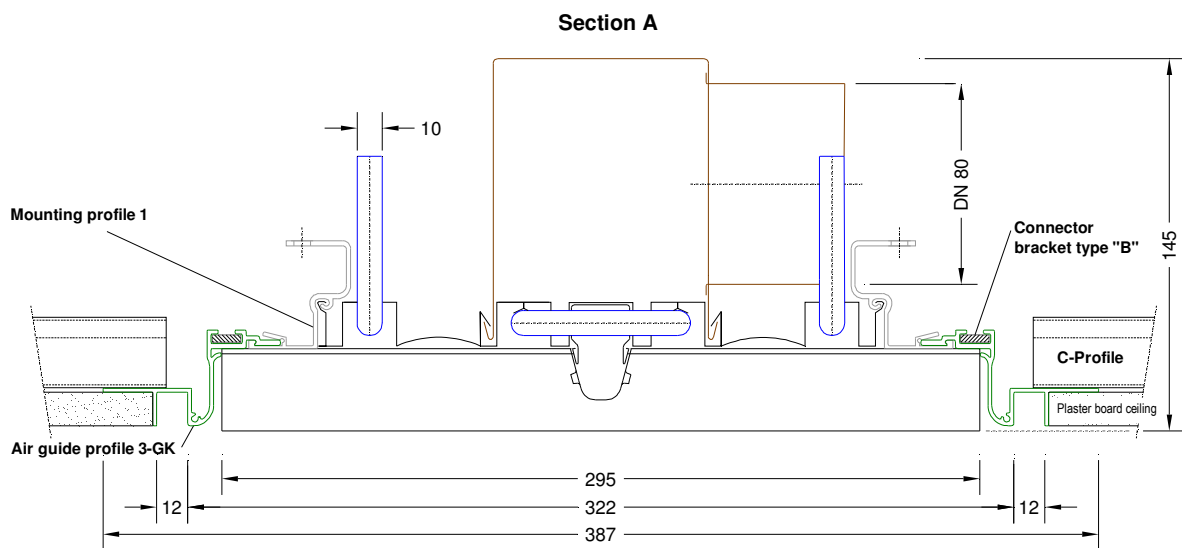
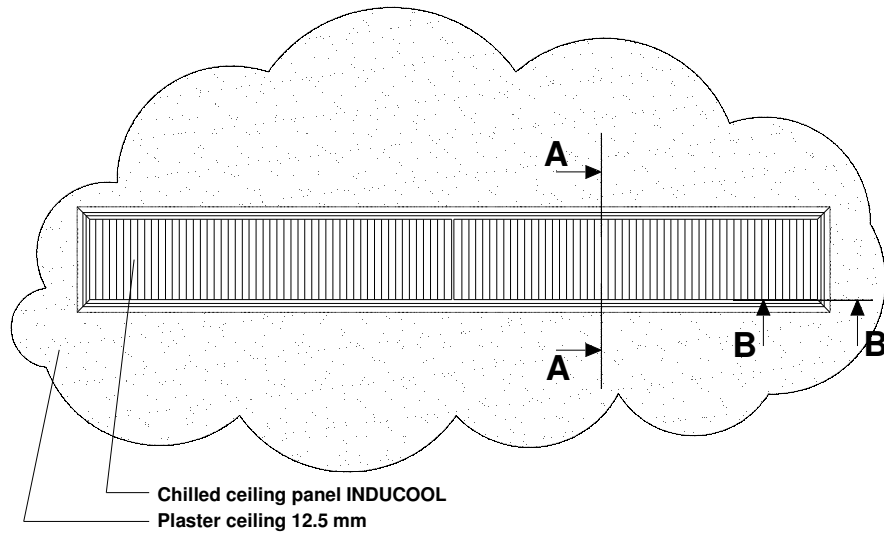

Revision and dummy element

(depicted at band-end)

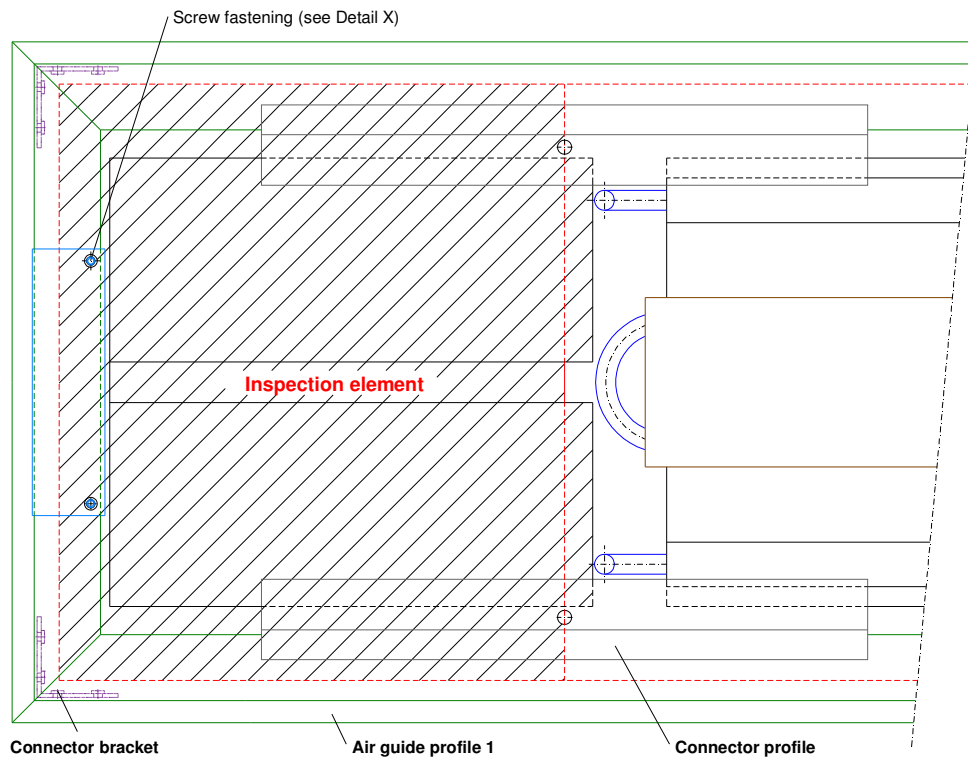
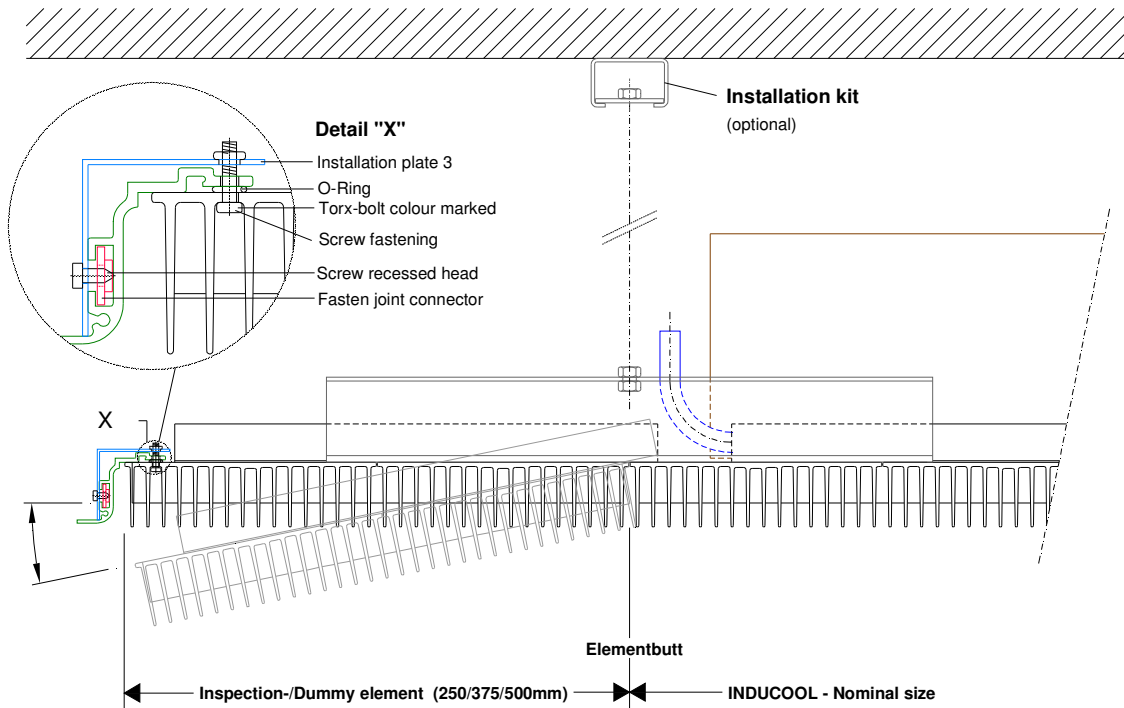

High-performance chilled ceiling panel INDUCOOL

In compact design with integral air entry via the proven draught-free INDUL technology. Can be combined with every ceiling system.

Consists of:

- INDUL air entry with air feed guide especially adapted to the application and 80 mm supply air connection socket
- Cooling water tubing (copper tube \varnothing 10 x 1 running in meanders along panel) pressed into aluminium heat transfer profile with soldered connections or union couplings (d = 10 mm)
- Finely ribbed heat transfer profile ((width 295 mm)
- Mounting profile for suspending the panel from threaded rods (rods not supplied)
- Required number of connector profile when mounting in rows

Chilled ceiling panel width: 337 mm (external dimensions with air guide profile 1)

- Air guide profile type 1 in the same colour as ribs
- Colouring of visible ribs: Anodised aluminium, natural colour

*Please note that visual colour deviations may occur in comparison to other ceiling elements due to the ribbed structure of the INDUCOOL surface (depending on the light-source / -reflections).
Manufacturing tolerances in accordance with DIN ISO 2768 Part 1 and 2.

Manufacturer: **Kiefer**

Lengthmm
Cooling capacityW
Number of units

Accessories

Dummy elements

For visual elongation of a chilled ceiling panel

Coating

Surcharge for finishing the visible ribs in RAL colours of choice*

Revision element

Surcharge for removable revision element with the same appearance as the of the active chilled ceiling panel

90° corner element

For connection of two rectangular arranged chilled ceiling panels

Installation kit

For easy installation with the advantage of the possibility to align the element in the x/y axis in an already installed state

Overlay bracket

For face-side support of a ceiling mounting rail

Air guide profile/ Installation frame KL1...3-GK

For easy integration into various standard ceilings

Cold water connection with diffusion resistant reinforced hose

For connecting the chilled ceiling panels with the cold water piping network

The full specification text can be downloaded from our website www.kieferklima.de.



Required specifications for the technical design and proposal preparation:

Receiver:

Sender:

Fax No.: +49 711 / 8109-205

Maschinenfabrik Gg. Kiefer GmbH

Heilbronner Straße 380-396

70469 Stuttgart, Germany

Chilled ceiling panel INDUCOOL

Project

Project no. customer.: _____

Date/Contact:.: _____

Project no. Kiefer.: _____

Room or module designation		Sample room			
Number of rooms / modules		1			
Specific supply air flow rate	[m ³ /hm ²]	8			
Room width	[m]	4			
Room length	[m]	5			
Area	[m ²]	20			
Room height	[m]	2			
Cooling capacity	[W/m ²]	80			
Ambient air temperature	[°C]	26			
Supply air temperature	[°C]	14			
Water supply temperature	[°C]	15			
Temperature difference, water	[K]	2			
Ambient air velocity	[m/s]	0,15			
Measurement level	[m]	1,3			
Sound pressure level in room	[dB(A)]	38			
With reverberation time	[s]	0,8			
Desired element length	[m]	1,5			



Product range

Components:

Linear, wall, ceiling and displacement diffusers, chilled ceiling systems, ceiling fan coil systems, transfer ducts, concrete core cooling with air.

Axial- and radial ventilators, gas-fired ventilators, plastic ventilators.

Systems:

All types of conditioning systems for maximum comfort (offices, administrative buildings, stores, hospitals, libraries, museums and similar) and industrial applications (machine construction, high-tech, textile, plastics, chemicals, automotive, food and drink industry and similar).

Services

Consulting and planning

We provide advice concerning all aspects of our systems and create system analyses and cost estimates based on cooling load / pipe network / energy cost / efficiency calculations. We also develop proposals concerning suggested layouts for air distribution, lighting and ceiling systems; and compile lighting-related data using the latest software tools, as well as developing and implementing control-technology related concepts in our own MSR division.

We are furthermore able to draw on a wealth of experience from previous projects when it comes to designing innovative products and new projects.

Laboratory:

Certificates, 1:1 room airflow laboratory analyses; acoustic and aerodynamic analyses of air-conditioning modules. Development of innovative air conditioning components. Caloric performance measurements of air and water-related components on test stands.

On-site comfort measurements to assess thermal comfort and indoor air quality.

Maintenance and servicing

All kinds of air-conditioning and climate control systems as part of maintenance and service contracts.

